

KIMAX®

Laboratory Glass Drain and Vent Systems



SCHOTT
glass made of ideas

Index



KIMAX® Drainline Piping Systems for Drain and Vent Applications

- 4 Technical Data
- 8 Guide Specifications
- 10 Pipe and Fittings
- 17 Couplings
- 18 Traps
- 21 Accessories and Hardware
- 23 Portable Field Cutting Tools
- 24 Joint Reference Chart
- 4, 8 U.L. Classification – Penetrating
Fire Walls and Floors

*For drainline installation data,
see separate catalog.*





This catalog contains performance, engineering, installation and specification data for KIMAX Glass Drain and Vent Systems manufactured by SCHOTT.

KIMAX Drainline Systems are designed for gravity flow. Borosilicate glass pipe and fittings are joined with bead-to-bead and bead-to-plain end compression couplings in diameters 1 1/2" through 6". Detailed installation instructions are offered in the KIMAX glass drainline installation guide. For application and installation assistance, contact your local KIMAX Drainline distributor or SCHOTT North America, Inc.

With over 40 years of uninterrupted manufacturing and sales of KIMAX Systems, the use of glass drain and vent systems continues to grow. More and more specifiers, building owners and contractors recognize that glass pipe systems will not corrode, will not burn or emit toxic fumes, are easy to handle and install, and offer the best value per dollar.



KIMAX® is a registered trademark of Kimble Glass Inc.

© Copyright of SCHOTT North America, Inc. 2006 All rights reserved

KIMAX® Glass Drainlines Eliminate Drain and Vent Problems

Yes, the projected service life of KIMAX Glass Drainlines is as long as the life of the building itself. KIMAX Glass Drainlines are the most cost-effective, corrosion-resistant and long-lasting materials available for drain and vent lines.

Made of borosilicate glass – the same type of glass used for laboratory glassware – KIMAX Glass Drainlines are impervious to almost every corrosive and reagent known. Acids that would destroy most plastics have no effect on KIMAX Glass Drainlines.

KIMAX Glass Drainlines are transparent, so you can find blockages easily. They're rugged too. KIMAX Glass Drainlines hold up to physical conditions that would destroy most plastic drainlines. KIMAX Glass Drainlines can handle liquids as hot as boiling water; they won't burn; and they won't melt or soften like many plastics. They are UL classified and even meet ASTM specifications for underground service.

KIMAX Glass Drainlines are used in research, teaching and industrial laboratories; hospitals; and chemical, food and other processing plants.



Firewalls Stay Firewalls with KIMAX Glass Drainline.

Laboratories can be hazardous. In fact, the National Fire Protection Association classifies all laboratories as hazardous areas and requires that they be segregated with minimum one-hour fire walls and floors. But, laboratory drainlines and vents must penetrate these floors and walls.

KIMAX Glass Drain and Vent Systems are Underwriter's Laboratory approved for Through Penetrating Firestops. Installed with firestop sealant, KIMAX corrosive resistant drain and vent systems meet UL Standard for Safety UL 1479 and its equivalent ASTM E-814.

Unlike plastic pipe, KIMAX Glass Drainlines don't burn or give off toxic vapors. If the fire is hot enough, KIMAX will sag and "tear drop", sealing itself and confining the fire. (See picture at bottom of page.)

KIMAX Glass Drainline Systems are the original UL classified approved drain and vent line for Through Penetrating Firestops. With our technology leadership and commitment to safety, SCHOTT is continuing to develop improved, cost-effective UL-approved drain and vent systems.



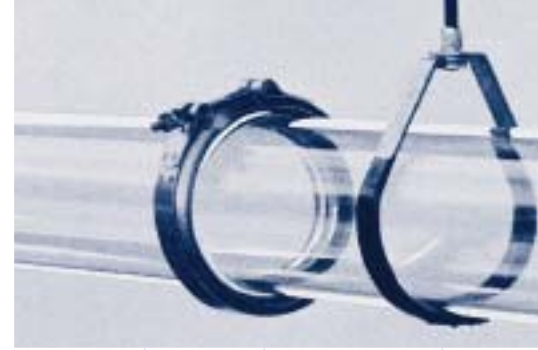
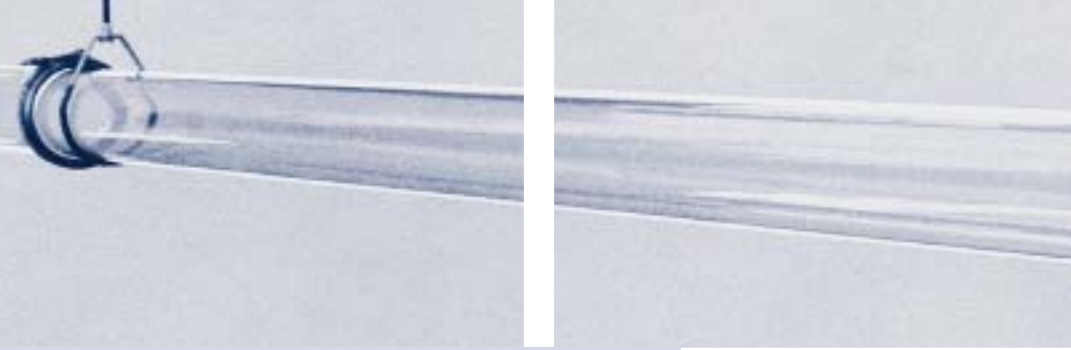

KIMAX Glass Pipe requires less hangers than polypropylene and high silicon iron pipes – only one hanger every 8 to 10 feet.

KIMAX Glass Drainlines Installation is Simple

Joints are easy to make, rugged and reliable: Installing KIMAX Glass Drainlines is fast and inexpensive – even faster and less costly than less effective materials like polypropylene pipe. Here's why:

- Glass pipe is lightweight and doesn't sag, even when it's hot. So it requires fewer hangers than high silicon iron or plastic pipes. The recommended hanger spacing for all sizes of KIMAX Glass Drainlines is every 8–10'. Polypropylene pipe manufacturers recommend hangers every 4–6' depending on the pipe diameter.
- Since glass pipe has a low coefficient of expansion, no expansion loops or joints are needed. Its coefficient of expansion – 0.2"/100 ft/100 °F – is lower than any other drainline material. Polypropylene pipe needs expansion joints and/or loops.
- The UL classified firewall penetration system is simple, easy to install and effective.
- Couplings for KIMAX Glass Drainlines require no field beading, welding or fusion. To assemble a drain or vent system with the KIMAX bead-to-plain coupling, the pipe is merely cut, inserted into the coupling, and a bolt is tightened. The two pieces of pipe can even be up to 4° out of line.

The installed cost of a KIMAX Glass Drainlines system is cost-competitive and often less expensive than other drainline systems.

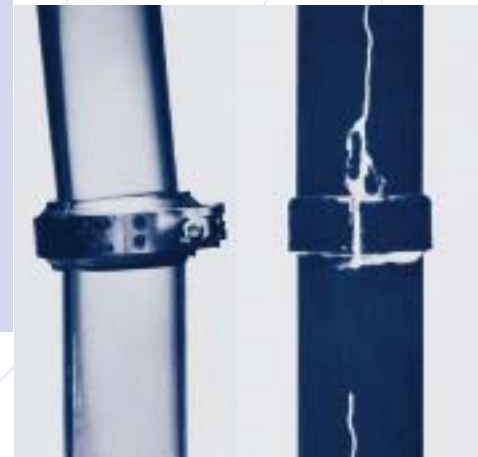

Left: KIMAX Couplings provide leak-free seals even when deflected up to 4°. Right: Plastic systems do not provide joint deflection capability.

Caution: Suitable safeguards for equipment and personnel must be provided when glass pipe is used under gas pressure, due to the potential energy of gases under pressure or vacuum.

KIMAX Glass Drainline Couplings – Quick and Secure

Two types of couplings are used to join KIMAX Glass Drainline pipes and fittings – bead-to-bead and bead-to-plain end. Both types have a 300-series stainless steel outer shell, a Buna-N compression liner, and a TFE seal ring. With a KIMAX Coupling, only glass and TFE contact the fluid.

Bead-to-bead (B/B) Couplings are formed by placing the two beaded drainline ends into a coupling and tightening the bolt. This type of coupling is normally used when installing long runs of pipe that require no cutting. KIMAX Glass Drainline comes from the factory with a bead on each end. When the pipe must be cut in the field, use the KIMAX Bead-to-Plain end Coupling.

Bead-to-plain end (B/P) Couplings eliminate field beading and are applied when pipe needs to be field cut. Only one pipe or fitting end requires a bead. The other pipe end needs only to be cut.

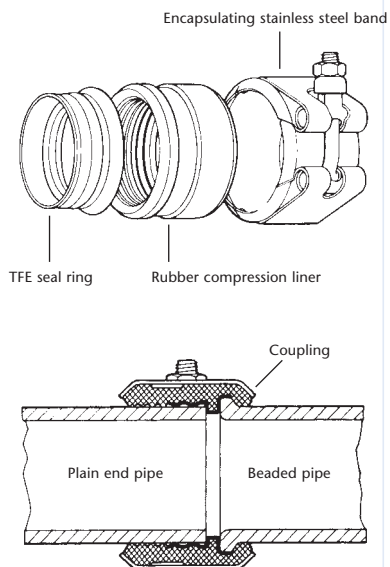

KIMAX Bead-to-Plain end Coupling components.

To form a B/P joint, the outside edge of the cut pipe is wiped with an emery cloth to eliminate the sharp edge. The beaded pipe end is wetted, the two pipe ends are placed into the coupling, and the bolt tightened.

The KIMAX B/P Coupling has performed successfully in the field for more than 20 years, including underground installations. With KIMAX B/P Couplings, installation labor is minimized and the possibility of error in forming a bead in the field is eliminated.

All couplings are not alike. KIMAX B/P Couplings are designed to stand up to harsh operating conditions. Tested by an independent testing laboratory, KIMAX B/P Couplings were found to be sound even after simulated 20-year testing.



Joining KIMAX Pipe with bead-to-plain end coupling.

KIMAX B/P Couplings Passed the Following Tests

- **Simulated 20-year underground corrosion test:** Immersion in hydrochloric, nitric and sulfuric acid (pH of 2.6) or sodium hydroxide (pH of 8.0) for 15 days at 186°F, KIMAX B/P Couplings still did not leak and retained their strength. They will not pull apart, even with a 375-pound pull force.
- **Thermocycle test:** With the two pipes deflected 4°, the KIMAX B/P Coupling was subjected to thermocycles from 0°F to 200°F. A 25 psi pressure check showed no leakage after any of the temperature cycles, and a 375-pound pull would not pull the coupling apart.
- **Deflection testing:** While under 25 psi internal pressure, the coupling was flexed over its 4° deflection range 15,000 times. No leakage occurred and the coupling still would not pull apart with a 375-pound pull.

(Details of the B/P coupling tests, performed by Pittsburgh Testing Laboratories, are available upon request.)

KIMAX Glass Drainlines for Long-Lasting, Durable Underground Installations

The toughness and durability of KIMAX Glass Drainline is demonstrated by its superior performance in thousands of underground installations. Underground drains have more exacting performance criteria than above-ground drains.

KIMAX Glass Pipe is corrosion resistant, it can handle future anticipated requirements. And glass pipe is not affected by external corrosion either. KIMAX Glass Drainlines are unaffected by lime, moisture, and other materials in the soil. The smooth, non-porous surface of a KIMAX Glass Drainline minimizes plugging and scale build-up – an important feature for buried pipe.

KIMAX Glass Drainlines are also tough enough to withstand the rigors of underground installation methods. EPS*-covered KIMAX Glass Drainlines meet or exceed ASTM requirements for buried heavy schedule cast iron pipe. EPS-covered KIMAX Glass Drainline passes the ASTM three-edge bearing test, the impact test, and the earth loading test. (Testing report from Pittsburgh Testing Laboratory available upon request.)

KIMAX B/P Couplings not only resist internal and external corrosion, but their ability to deflect up to 4° without leaking allows buried KIMAX Glass Drainlines to flex with shifting ground conditions.



**EPS is Expanded Polystyrene*

KIMAX Pipe Cutting Tools Reduce Contractor Installation Costs

KIMAX Cutting Tools enable contractors to quickly field cut special lengths of 1 1/2" through 6" drainline pipe. In addition to our standard 1 1/2" through 6" cutter, a tool specifically designed for 1 1/2" and 2" diameter pipe is available. This model is offered as approximately 80% of field cuts are 1 1/2" and 2" pipe. By reducing the size of the head and changing the design of the cutter arms, contractors can more easily insert/withdraw and extend/contract the cutter head and arms, thereby reducing installation costs.

The 1 1/2" and 2" cutter head connects to our standard extension handle and tension handles, enabling contractors to purchase this head for use with existing handles.

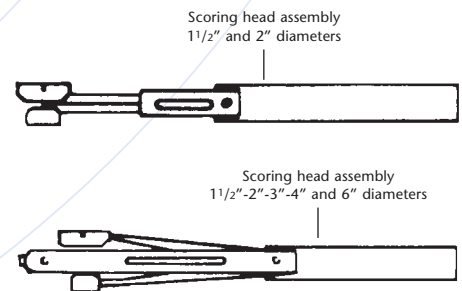

Additional information on field cutting tools is available by contacting your local KIMAX distributor or SCHOTT North America, Inc. Also see page 23 of this catalog.

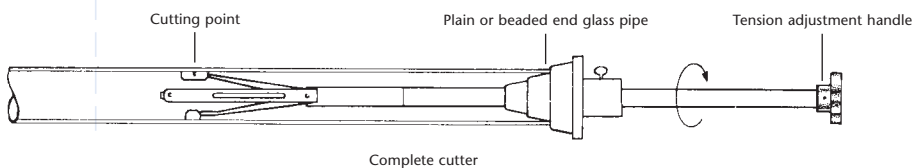

Guide Specifications

Long Form: Acid Waste Drain and Vent Piping System

I. General:

- a) Contractor shall furnish and install a complete acid waste drain and vent system as indicated. This system shall be made of U.L. Classified borosilicate glass conforming to ASTM Specification C 1053-90, Federal Specification DD-G-541 B and Military Specification MIL-P-22561 B (YD) as manufactured under the trade name "KIMAX" by SCHOTT.
- b) This system shall include all glass straight lengths, fittings, and traps, compression type tetra-fluoroethylene lined couplings, and padded hanger supports. It shall also include protected pipe for underground burial and recommended adapter couplings to connect other piping material, where applicable.
- c) All pipe shall be installed free of strain, in a manner to permit limited movement. Padded pipe hangers shall be used on horizontal runs 8' to 10' on centers. Vertical risers shall be supported by padded riser clamps designed to restrict lateral and downward movement. Vertical risers up to 3" I.D. may be supported at every other floor level. Three-inch I.D. and greater shall be supported at every floor level.

II. Connections

- a) Glass-to-glass connections shall be made with KIMAX compression type bead-to-bead and bead-to-plain end couplings – article numbers 6650 and 6661 respectively. Coupling's outer shell, bolt and nut to be made from 300 series stainless steel. Bead-to-plain end coupling outer shell must encapsulate compression liner to prevent cold flow and ensure leak-free joint. Coupling compression liner to be made from Buna-N-Rubber. Seal ring gasket to be made of tetra-fluoro ethylene. When installed according to the manufacturer's recommendations, they shall provide a leak-free joint when deflected up to 4°.
- b) Joints between glass and other types of piping material shall be made with KIMAX Adapters, and/or according to manufacturer's recommendations.

III: Floor and wall penetrations

- a) Glass pipe passing through non-fire rated walls or floor slabs shall be fitted with pipe sleeves a minimum of 2" greater diameter than the pipe O.D. Space between pipe and sleeve shall be packed with fiber glass, glass wool and/or a non-hardening approved caulking material.
- b) Glass pipe passing through fire-rated walls or floor slabs shall be installed in accordance with Underwriters Laboratory fire penetration systems for KIMAX Glass Pipe. System numbers listed in the U.L. Fire Resistance Directory include: C-AJ-2006, 2014, 2019, 2039, 2079, 2094, 2118, 2144, 8005, 8035; W-J-2032; W-L-2006, 2112, 2114.
- c) Glass pipe shall not be installed in direct contact with concrete. Fiber glass insulation or other type padding as approved by the pipe manufacturer shall be used to insulate between the two materials.
- d) Glass pipe shall be protected against all weld spatter.



IV. Installation and testing

Install and test in accordance with manufacturer's recommendations and national and/or local code requirements.

V. Underground pipe

- a) Excavation – shall conform to National Plumbing Code A 40.8 Section 2.7.
1. Bottom of trench shall be properly compacted, graded, and the pipe supported throughout its entire length.
 2. A minimum of 4" of properly compacted rock-free sand or soil shall be used directly under the pipe.

b) Buried Pipe

1. Pipe shall be 6502 series – 5-ft. lengths covered with expanded polystyrene.
2. All underground fittings shall be protected prior to back-filling by wrapping in polyvinyl film (5 mil), Scotch Wrap or J.M. Trans-Tex or approved equal.

c) Backfill

Pipe trench shall be back-filled and tamped with rock-free sand or soil to 12" above top of pipe. Where space does not permit a minimum 12" cover, additional protection must be provided to protect pipe against crushing loads, except when buried under protective concrete slab.

VI. Laboratory sink connection

Sink outlets, tailpieces, traps and cup sinks shall be KIMAX Borosilicate Glass.

Short Form: Acid Waste Drain and Vent Piping System

System shall be made of KIMAX U.L. Classified borosilicate glass and conforming to ASTM Specification C 1053-90, Federal Specification DD-G-541-B and Military Specification MIL-P-22561-B (YD) as manufactured by SCHOTT. Glass-to-glass connections shall be made with KIMAX compression type bead-to-bead and bead-to-plain end couplings – article numbers 6650 and 6661 respectively. Coupling's outer shell, bolt and nut to be made from 300 series stainless steel. Bead-to-plain end coupling outer shell must encapsulate compression liner to prevent cold flow and ensure leak-free joint. Inner seal ring is made of tetra-fluoroethylene. System shall be installed in accordance with the manufacturer's recommendations and the governing plumbing code.

Underground Glass Pipe: Excavation shall conform to National Plumbing Code A 40.8 Section 2.7. Bottom of trench shall consist of a minimum 4" of rock-free sand or soil, compacted and graded to provide uniform full length support. Back-fill with rock-free sand and/or soil to 12" above pipe. When the above conditions cannot be met, consult the manufacturer for recommendations. KIMAX Protected Pipe, and wrapped fittings shall be installed and back-filled in accordance with the manufacturer's instructions and governing plumbing code.

Pipe and Fittings

Standard lengths of KIMAX Drainline Pipe are 5 feet and 10 feet. Special lengths (both ends beaded) are available on request.

6500 5-FT. LENGTHS
6501 10-FT. LENGTHS

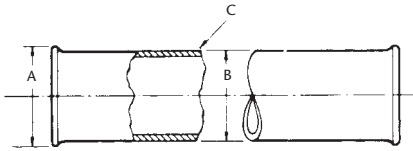

Size	Weight lbs./ft.	A	B (O.D.)	C (Wall)	5-ft. lengths Art. No.	10-ft. lengths Art. No.
1 1/2	0.87	2.06	1.84	0.18	6500-1500	6501-1500
2	1.1	2.58	2.34	0.17	2000	2000
3	2.0	3.69	3.41	0.20	3000	3000
4	3.4	4.84	4.53	0.26	4000	4000
6	6.3	7.12	6.66	0.33	6000	6000

HW 7035 EPS DRAINLINE COVERS⁽¹⁾
5-FT. LENGTHS (FOR UNDERGROUND USE)⁽²⁾

HW 7035 EPS drainline covers are designed and recommended for installation underground. Maximum length, for one piece, recommended for such installation is 5 feet.

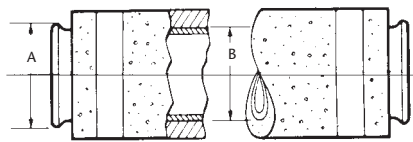

EPS Covers Art. No.

HW 7035 P -1500
-2000
-3000
-4000
-6000

¹⁾Expanded Polystyrene
²⁾4 Pieces=5 ft.

6511 SWEEPS

1. 1/4 bend (90°)
2. 1/6 bend (60°)
3. 1/8 bend (45°)
4. 1/16 bend (22 1/2°)

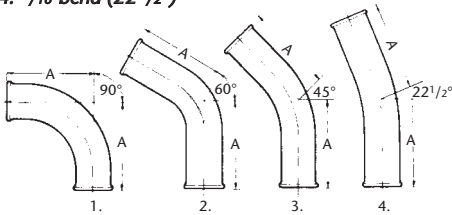

Size	A	90° Art. No.	60° Art. No.	45° Art. No.	22 1/2° Art. No.
1 1/2	4 1/2	6511-1590	6511-1560	6511-1545	6511-1522
2	5	2090	2060	2045	2022*
3	6 1/2	3090	3060*	3045	3022*
4	9	4090	4060*	4045	4022*
6	12	6090	6060*	6045	6022*

6513 BENDS

1. 1/4 bend (90°)
2. 1/6 bend (60°)
3. 1/8 bend (45°)
4. 1/16 bend (22 1/2°)

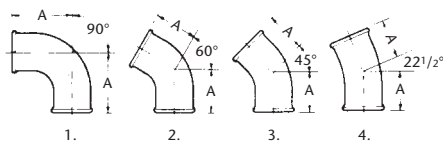

Size	A 90°	A 60°	A 45°	A 22 1/2°	90° Art. No.	60° Art. No.	45° Art. No.	22 1/2° Art. No.
1 1/2	3	2 1/2	2	2	6513-1590	6513-1560	6513-1545	6513-1522
2	3 1/4	2 3/4	2 1/4	2 1/4	2090	2060	2045	2022
3	5	3 1/2	2 3/4	2 3/4	3090	3060*	3045	3022*
4	7	4 1/2	3 1/4	3 1/4	4090	4060*	4045	4022*
6	-	-	7	-	-	-	6045	-

Use catalog dimensions for piping layout as gasket thickness allowance is included.
*Manufactured per order. Not returnable.

Offsets made using Standard Sweeps and Bends

Because of a wide variety of offset requirements, use a combination of bends (6511 and/or 6513). Order quantity of bends and KIMAX Couplings (No. 6650) to satisfy offset dimensional requirements. Combinations do not come equipped with couplings.

Size	1/4		1/6		1/8		1/16	
	L	O	L	O	L	O	L	O
1 1/2	9	9	13 1/2	7 7/8	15 3/8	6 3/8	17 3/8	3 3/8
2	10	10	15	8 3/4	17 1/8	7 1/8	19 1/4	3 7/8
3	13	13	19 1/2	11 1/4	22 1/4	9 1/4	25	5
4	18	18	27	15 5/8	30 3/4	12 3/4	34 5/8	6 7/8
6	24	24	36	20 3/4	41	17	46 1/4	9 1/4

Size	1/4		1/6		1/8		1/16	
	L	O	L	O	L	O	L	O
1 1/2	6	6	7 1/2	4 3/8	6 7/8	2 7/8	7 3/4	1 1/2
2	6 1/2	6 1/2	8 1/4	4 3/4	7 3/4	3 1/4	8 5/8	1 3/4
3	10	10	10 1/2	6 1/6	9 3/8	3 7/8	10 1/2	2 1/8
4	14	14	13 1/2	7 7/8	11 1/8	4 5/8	10 3/4	2 1/2

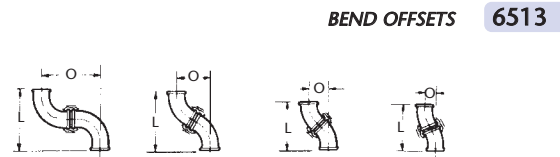
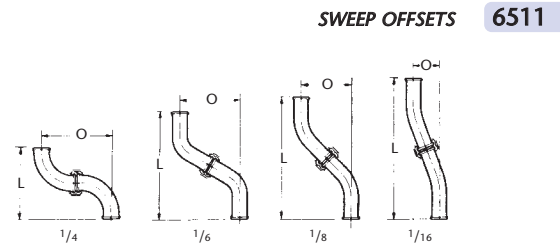

Special Purpose Bends

Size	A	B	Art. No.
1 1/2-90°	3 3/8	6	6512-1590
2 -90°	3 5/8	7 1/2	2090

LONG 90° 6512

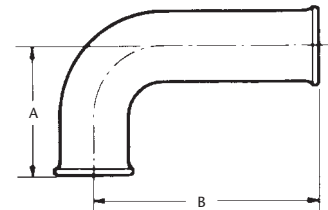

Size	A	B	Art. No.
1 1/2-90°	3 3/8	12	6512P-1590
2 -90°	3 5/8	12	2090

(ANNEALED) PLAIN END 6512P¹⁾

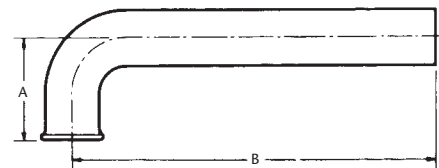

¹⁾Can be field cut.

Size	A	B	Art. No.
1 1/2-90°	2 1/2	3	6514-1590

SHORT 90° 6514

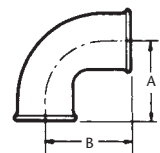

Use catalog dimensions for piping layout as gasket thickness allowance is included.

6518 QUARTER BEND REDUCER

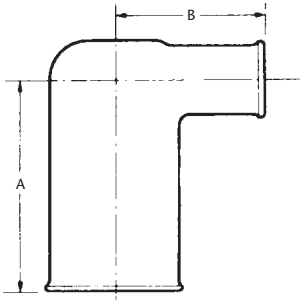

Size	A	B	Art. No.
2 x 1 1/2	4	3 1/2	6518-2015
3 x 1 1/2	5	4	3015 *
3 x 2	5	4 1/2	3020 *
4 x 1 1/2	7	4 1/2	4015 *
4 x 2	7	5	4020 *
4 x 3	7	5 1/2	4030 *
6 x 1 1/2	9	5 1/2	6015 *
6 x 2	9	6	6020 *
6 x 3	9	6 1/2	6030 *
6 x 4	9	8	6040 *

6519 DOUBLE QUARTER BEND

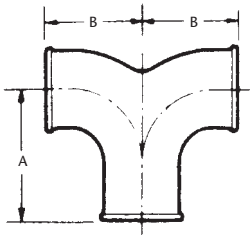

Size	A	B	Art. No.
1 1/2	3	2 1/8	6519-1500
1) 2 x 2 x 1 1/2	3 1/4	2 1/4	1) 2015 *
2	3 1/2	2 1/4	2020
3	5	4 1/2	3000 *
4	6 1/2	5 3/4	4000 *
6	8 1/2	7	6000 *

1) Branch is 1 1/2" I.D.

6519P DOUBLE QUARTER BEND (PLAIN END OUTLET)²⁾

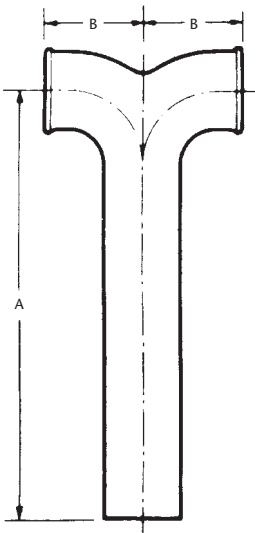

Size	A	B	Art. No.
1 1/2	10	2 1/8	6519P-1500 *
1) 2 x 2 x 1 1/2	10	2 1/4	1) 2015 *
2	10	2 1/4	2020 *
3			
4			
6			

1) Branch is 1 1/2" I.D.

2) Can be field cut.

Use catalog dimensions for piping layout as gasket thickness allowance is included.
*Manufactured per order. Not returnable.

Size	A	B	C	Single Art. No.	Double Art. No.
1 1/2 x 1 1/2	6	3 1/2	3 3/4	6521-1515	6522-1515
2 x 1 1/2	8	3 3/4	5	2015	2015
2 x 2	8	4 1/2	5	2020	2020
3 x 1 1/2	12	4 1/4	7 7/16	3015	3015 *
3 x 2	12	5	7 7/16	3020	3020
3 x 3	12	6 3/8	7 7/16	3030	3030
4 x 1 1/2	14	4 7/8	8 3/4	4015	4015 *
4 x 2	14	5 5/8	8 3/4	4020	4020 *
4 x 3	14	7	8 3/4	4030	4030 *
4 x 4	14	8 1/4	8 3/4	4040	4040 *
6 x 2	20	6 3/4	12 3/8	6020 *	6020 *
6 x 3	20	8	12 3/8	6030 *	6030 *
6 x 4	20	9 5/16	12 3/8	6040 *	6040 *
6 x 6	20	12	12 3/8	6060 *	6060 *

SINGLE SANITARY T 6521

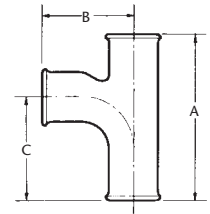

DOUBLE SANITARY T 6522

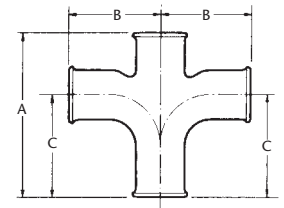

Size	A	B	C	Art. No.
1 1/2 x 1 1/2	6	3	3	6523-1515
2 x 1 1/2	8	3 1/4	4	2015
2 x 2	8	4	4	2020
3 x 1 1/2	12	4 1/2	6	3015 *
3 x 2	12	4 1/2	6	3020
3 x 3	12	6	6	3030
4 x 1 1/2	14	5	7	4015 *
4 x 2	14	5	7	4020
4 x 3	14	6 1/2	7	4030 *
4 x 4	14	8	7	4040
6 x 3	20	7 3/4	10	6030 *
6 x 4	20	9	10	6040 *
6 x 6	20	10	10	6060 *

STRAIGHT T 6523

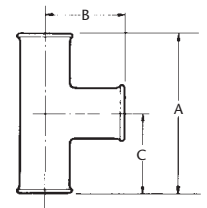

Size	A	B	C	D	Art. No.
1 1/2 x 1 1/2	6	2 3/16	3	3 1/16	6524-1515
2 x 2	8	2 11/16	4	3 11/16	2020
3 x 3	12	3 9/16	6	4 11/16	3030
4 x 4	14	4 5/8	7	5 7/8	4040

TEST T WITH CLEANOUT 6524

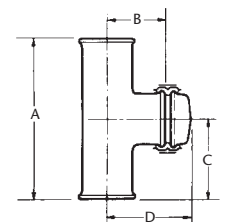

Test T and cleanout comes as complete assembly including cap and coupling.

Use catalog dimensions for piping layout as gasket thickness allowance is included.
*Manufactured per order. Not returnable.

6526 DRAINLINE Y SINGLE

6527 DRAINLINE Y DOUBLE

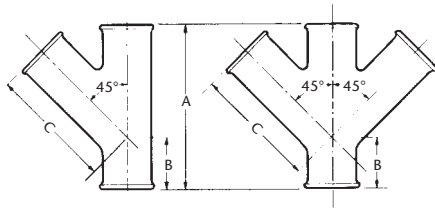

Size	A	B	C	Single Y Art. No.	Double Y Art. No.
1 1/2 x 1 1/2	6	1 7/8	4 1/2	6526-1515	6527-1515 *
2 x 1 1/2	8	2 1/2	4 3/4	2015	2015 *
2 x 2	8	2 1/2	6	2020	2020 *
3 x 1 1/2	12	3 3/4	5 1/2	3015	3015 *
3 x 2	12	3 3/4	6 3/4	3020	3020 *
3 x 3	12	3 3/4	8	3030	3030 *
4 x 1 1/2	14	4 1/2	6 3/8	4015 *	4015 *
4 x 2	14	4 1/2	7 1/2	4020	4020 *
4 x 3	14	4 1/2	8 3/4	4030	4030 *
4 x 4	14	4 1/2	10	4040	4040 *
6 x 2	20	5 3/4	9	6020 *	6020 *
6 x 3	20	5 3/4	10 3/8	6030 *	6030 *
6 x 4	20	5 3/4	11 1/2	6040 *	6040 *
6 x 6	20	5 3/4	14	6060 *	6060 *

6528 COMBINATION Y AND 1/8 BEND – SINGLE

6529 COMBINATION Y AND 1/8 BEND – DOUBLE

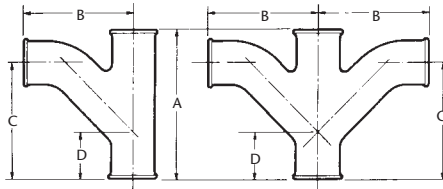

Size	A	B	C	D	Single Art. No.	Double Art. No.
1 1/2 x 1 1/2	6	4 1/2	4 5/8	1 7/8	6528-1515	6529-1515
2 x 1 1/2	8	4 3/4	5 1/2	2 1/2	2015	2015
2 x 2	8	6	6 1/4	2 1/2	2020	2020
3 x 1 1/2	12	5 3/8	7 1/4	3 3/4	3015	3015 *
3 x 2	12	6 1/2	8	3 3/4	3020	3020 *
3 x 3	12	8 1/2	9	3 3/4	3030	3030 *
4 x 1 1/2	14	6	8 1/2	4 1/2	4015	4015 *
4 x 2	14	7	9 1/4	4 1/2	4020	4020 *
4 x 3	14	9	10 1/4	4 1/2	4030	4030 *
4 x 4	14	11	11	4 1/2	4040	4040 *
6 x 2	20	8 1/4	11 5/8	5 3/4	6020 *	6020 *
6 x 3	20	10	12 1/2	5 3/4	6030 *	6030 *
6 x 4	20	12	13 1/2	5 3/4	6040 *	6040 *
6 x 6	20	15	14 1/2	5 3/4	6060 *	6060 *

6531 PARTITION CROSS (COMPACT)

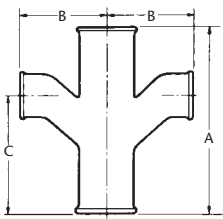

Size	A	B	C	Art. No.
2 x 1 1/2	8	3 3/4	5	6531-2015 *
2 x 2	8	4 1/2	5	2020 *
2 x 1 1/2 x 1 1/2 x 1 1/2	8	3 3/4	5	2151 *

Partition crosses are designed to prevent cross-flow when sinks are connected back to back.

*Use catalog dimensions for piping layout as gasket thickness allowance is included.
Manufactured per order. Not returnable.

Size	A	B (min.)	Straight Art. No.	Eccentric Art. No.
2 x 1 ¹ / ₂	4	1 ³ / ₄	6536-2015	6537-2015
3 x 1 ¹ / ₂	5	2 ¹ / ₄	3015	3015*
3 x 2	5	2 ¹ / ₄	3020	3020*
4 x 1 ¹ / ₂	7	3	4015*	4015*
4 x 2	7	3	4020	4020*
4 x 3	7	3	4030	4030*
6 x 1 ¹ / ₂	9	4	6015*	6015*
6 x 2	9	4	6020*	6020*
6 x 3	9	4	6030	6030*
6 x 4	9	4	6040	6040*

STRAIGHT REDUCERS OR INCREASERS

6536

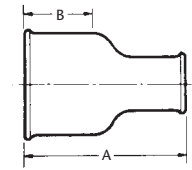

ECCENTRIC REDUCERS OR INCREASERS

6537

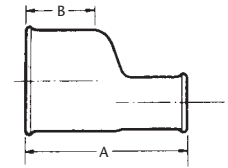

Size	A	Art.No.
1 ¹ / ₂	1	6544-1500
2	1	2000
3	1 ¹ / ₈	3000
4	1 ¹ / ₄	4000
6	1 ¹ / ₂	6000

CLEANOUT PLUG

6544



Size	A	B	Art. No.
1 ¹ / ₂	4	5	6550-1500
2	4 ¹ / ₂	5 ¹ / ₂	2000
3	5 ¹ / ₂	6 ¹ / ₂	3000
4	6 ¹ / ₂	7 ¹ / ₂	4000*

U BEND (VENT LOOP)

6550

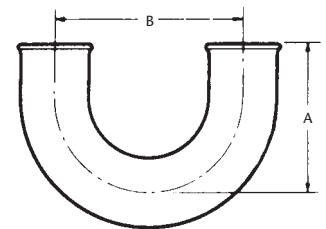

Note: U bends are often used for vent loops. No. 6705 outlets on Swivel "S" Traps are also used as vent loops.

Pipe Size	A	Art.No.
1 ¹ / ₂	3 ¹ / ₂	6566-1500
2	4	2000
3	5	3000
4	6	4000

"MJ" PIPE ADAPTER¹⁾

6566

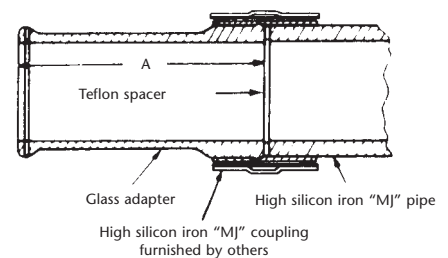

Glass Adapter to High Silicon Iron "MJ" Pipe

¹⁾ 6566 "MJ" Pipe Adapter consists of glass adapter and 6740 teflon spacer.

Use catalog dimensions for piping layout as gasket thickness allowance is included.
*Manufactured per order. Not returnable.

Cup Sinks

6619 BEADED OUTLET 3" x 6" OVAL

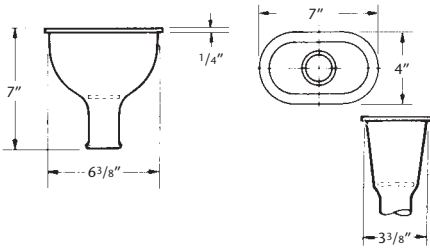

Art. No.

6619-3600

6619P PLAIN END OUTLET 3" x 6" OVAL

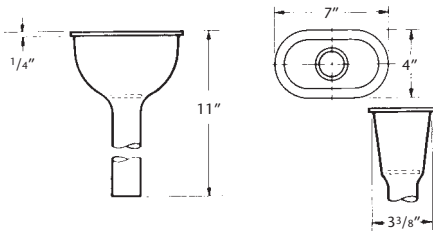

Art. No.

6619P-3611

6627 3" x 6" OVAL HORIZONTAL, WALL MOUNTED CUP SINK 1 1/2" PLAIN END OUTLET

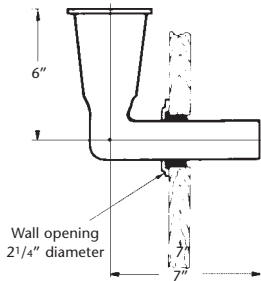

Art. No.

6627-3600*

Components Art. No.

6621-3600*

6724-2000*

Horizontal Outlet

No. 6621 cup sink oval (3 x 6)
No. 6724 2" sink strainer

Mounting bolts or screws to be furnished by installer. For No. 6627 assembly use No. 6655 adapter coupling (2 x 1 7/8") on outlet to connect to 2" expanded inlet.

6628 3" x 6" OVAL VERTICAL, 1 1/2" OUTLET WALL MOUNTED CUP SINK

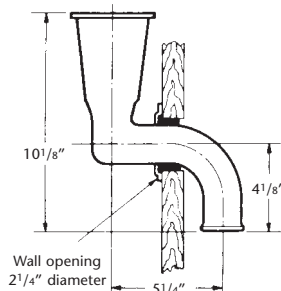

Art. No.

6628-3600*

Components Art. No.

6629-3600*

6624-2000*

Vertical Outlet

No. 6629 oval cup sink (3 x 6)
No. 6724 2" sink strainer

Mounting bolts or screws to be furnished by installer. For No. 6628 assembly use No. 6650 1 1/2" size KIMAX Coupling on outlet.

6724 SINK STRAINER (ALL CUP SINKS)

Size

Art.No.

1 1/2

6724-1500

2

6724-2000

Use catalog dimensions for piping layout as gasket thickness allowance is included.
*Manufactured per order. Not returnable.

Couplings

Size	A	B	C	D	Bolt Size	Art. No.
1 1/2	3	2 5/8	1 5/16	3/16	1/4 - 28 x 2 3/4	6650-1500
2	3 1/2	3 1/8	1 5/16	3/16	1/4 - 28 x 2 3/4	2000
3	4 3/4	4 1/4	1 7/16	3/16	1/4 - 28 x 2 3/4	3000
4	6	5 1/2	1 1/2	3/16	1/4 - 28 x 3 1/4	4000
6	8 1/4	7 3/4	1 7/8	1/4	5/16 - 24 x 4	6000

No. 6650 drainline coupling is used for joining 1 1/2", 2", 3", 4" and 6" KIMAX Glass Drainline pipe and fittings. No. 6650 KIMAX Coupling consists of:
 No. 6651 segmented stainless steel outer band
 No. 6652 Buna-N rubber compression liner with TFE seal ring
 No. 6653 stainless steel bolt
 No. 6664 silver plated stainless steel hex nut

DRAINLINE COUPLING (BEAD TO BEAD)

6650

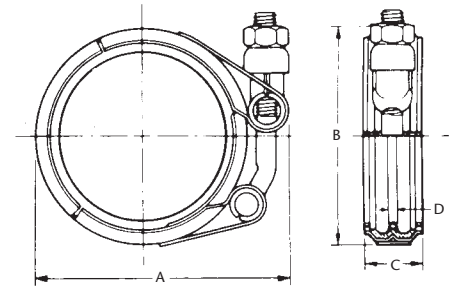

Size	Tailpiece Style	O.D. Size Range	Art. No.
2 x 1 1/2	KIMAX glass tail pipe extension No. 6728, metal tubing, and lead tailpiece extensions	1.48 to 1.53	6655-2015
2 x 1 3/4	Lead, Class D or XL tailpiece PYREX tailpiece and cup sink	1.70 to 1.78	2017
2 x 1 7/8	Plain end KIMAX 1 1/2 glass pipe or fittings Durcon = SO-2 Duriron = 11713 Lead-Class C or L, B or M Plastic or Steel (1 1/2 IPS)	1.82 to 1.90	2018

No. 6655 adapter assembly is used to join KIMAX Drainline Pipe and/or fittings to plain end sink tailpieces. The assembly consists of:
 No. 6651 segmented stainless steel outer band
 No. 6657 Buna-N rubber adapter
 No. 6656 TFE adapter seal
 No. 6653 stainless steel bolt, 1/4 - 28 x 2 3/4
 No. 6664 silver plated stainless steel hex nut

ADAPTER COUPLING

6655

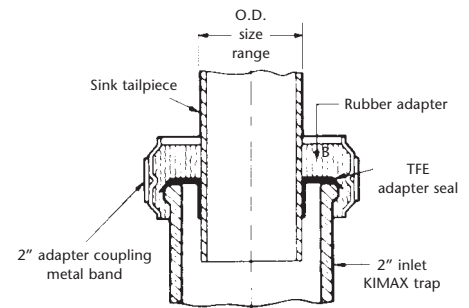

Size	A	B	C	D	Bolt Size	Art. No.
1 1/2	3	2 3/4	1 3/4	3/16	1/4 - 28	6661-1500
2	3 3/8	3 1/4	1 3/4	3/16	1/4 - 28	2000
3	4 11/16	4 1/4	2 9/16	3/16	5/16 - 24	3000
4	6	5 5/8	2 9/16	3/16	5/16 - 24 (2)	4000
6	8 5/8	7 7/8	4	1/4	5/16 - 24 (2)	6000

No. 6661 B/P drainline coupling is used for joining 1 1/2", 2", 3", 4" or 6" KIMAX Beaded Glass Drainline to plain end (cut) glass pipe; lead, I.P.S. metal, or plastic pipe. This exclusively designed KIMAX Drainline Coupling consists of the following components:
 No. 6662 stainless steel band with bolt
 No. 6663 Buna-N rubber compression liner with TFE seal ring
 No. 6664 silver plated stainless steel hex nut

B/P DRAINLINE COUPLING (BEAD-TO-PLAIN END)

6661

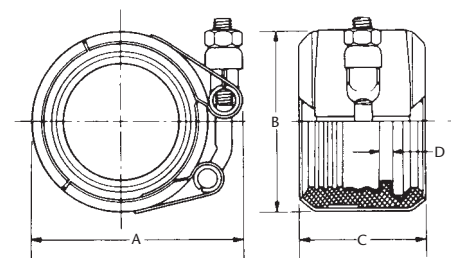

Use catalog dimensions for piping layout as gasket thickness allowance is included.

6665 ADAPTER COUPLING

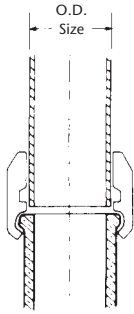

Size	Tailpiece Style	Art. No.
1 1/2 x 1 1/4	1 1/4 O.D. tubing	6665-1512*
1 1/2 x 1 1/2	1 1/2 O.D. tubing	1515

Used to join 1 1/2" beaded KIMAX Drainline Pipe to 1 1/4" or 1 1/2" O.D. tubing. Note: Rubber seal only – not recommended where solvents will come in contact with the coupling seal.

Drainline Traps

Expanded inlets of traps have 4" minimum depth to permit adjustment

6700 SWIVEL TRAP-P STYLE

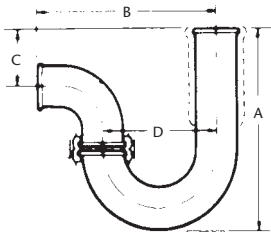

Size Inlet x Outlet	A	B	C	D	Art. No.
1 1/2 x 1 1/2	8 3/4	8	2	5	6700-1515
2 x 1 1/2	8 3/4	8	2	5	2015
2 x 2	9 11/16	8 3/4	1 5/8	5 1/2	2020

No. 6700 (short outlet) swivel "P" trap assembly consists of a No. 6705 inlet with a No. 6513 outlet and a No. 6650 KIMAX Coupling at the swivel joint. See Standard Cleanout, Page 20.

6701 SWIVEL TRAP-P STYLE

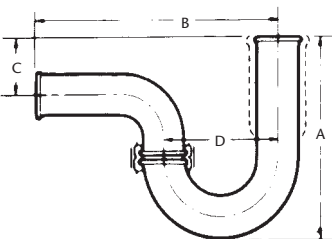

Size Inlet x Outlet	A	B	C	D	Art. No.
1 1/2 x 1 1/2	9 11/16	11	1 5/8	5	6701-1515
2 x 1 1/2	8 3/4	11	1 5/8	5	2015
2 x 2	8 3/4	13	1 1/4	5 1/2	2020

No. 6701 (long outlet) swivel "P" trap assembly consists of a No. 6705 inlet with a No. 6512 outlet and a No. 6650 KIMAX Coupling at the swivel joint. See Standard Cleanout, Page 20.

6704 SWIVEL TRAP-P STYLE (PLAIN END OUTLET¹⁾)

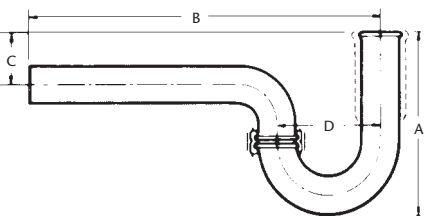

Size Inlet x Outlet	A	B	C	D	Art. No.
1 1/2 x 1 1/2	8 3/4	17	1 5/8	5	6704-1515
2 x 1 1/2	8 3/4	17	1 5/8	5	2015
2 x 2	9 11/16	17 1/2	1 1/4	5 1/2	2020

No. 6704 (plain end outlet) swivel "P" trap assembly consists of a No. 6705 inlet with a No. 6512P plain end outlet and a No. 6650 KIMAX Coupling at the swivel joint.

¹⁾ Plain end outlet, can be field cut.

Use catalog dimensions for piping layout as gasket thickness allowance is included.
*Manufactured per order. Not returnable.

Size Inlet x Outlet	A	B	C	D	Body I.D.	Art. No.
1 1/2 x 1 1/2	9	8	1	4 3/4	3	6706-1515 *
2 x 1 1/2	9	8	1 1/2	4 3/4	3	2015 *
2 x 2	9 3/4	9 1/4	2	5 1/2	4	2020 *

No. 6706 swivel "S" trap consists of two No. 6705 inlets and a No. 6650 KIMAX Coupling at the swivel joint.

SWIVEL TRAP-S STYLE 6706

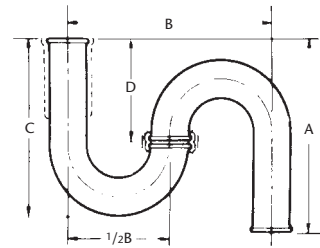

Size Inlet x Outlet	A	B	C	D	Art. No.
1 1/2 x 1 1/2	10	10	8 3/4	5	6707-1515
2 x 1 1/2	10	10	8 3/4	5	2015
2 x 2	9 3/4	11	9 11/16	4 7/8	2020

Traps available with B type cleanout. See Standard Cleanout, Page 20.

DRUM TRAP-P STYLE 6707

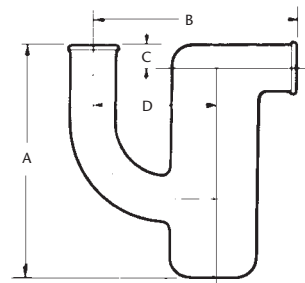

Size	Description	Art. No.
1 1/2 x 1 1/2	Interceptor Trap	6708-4015
1 1/4 O.D. Inlet	Adapter Coupling	6665-1512
1 1/2 O.D. Inlet	Adapter Coupling	6665-1515

Specifications:

KIMAX borosilicate glass interceptor trap with 1 1/2" I.D. inlet, 1 1/2" I.D. outlet and 4" I.D. body. Perforated S.S. screen interceptor 4" dia. with 1/16" holes and effective 6 sq. in. free area opening. Bottom C.O. coupling with end cap for cleaning.

Connections:

- For DWV Service use KIMAX Adapter Coupling 6665-1515 for 1 1/4" O.D. tubing or 6665-1512 for 1 1/4" O.D. tubing. Rubber seal only.
- To connect to 1 1/2" IPS metal or rigid plastic plain end pipe, use KIMAX B/P Coupling 6661-1500.
- To connect to 1 1/2" I.D. glass drainline, use KIMAX Couplings 6650-1500 or 6661-1500.

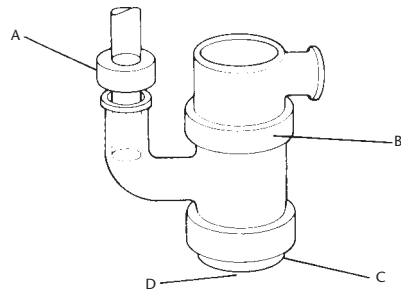

- Adapter coupling No. 6665-1512 (to connect to 1/4" O.D. tubing) (rubber seal) No. 6665-1515 (to connect to 1 1/2" O.D. tubing)
- Perforated S.S. screen 1/16" dia. holes 6 sq. in. free area opening
- Removable coupling/end cap for cleanout
- Min. 3" clearance required under trap for removal of end cap

INTERCEPTOR TRAP 6708

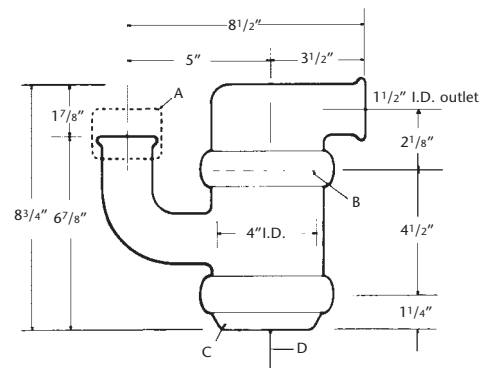

Use catalog dimensions for piping layout as gasket thickness allowance is included.
*Manufactured per order. Not returnable.

6710

SWIVEL DRUM TRAP-P STYLE

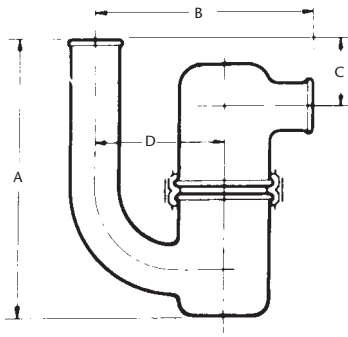

Size Inlet x Outlet	A	B	C	D	Body I.D.	Art. No.
1 1/2 x 1 1/2	10 1/4	8	2 1/2	4 3/4	3	6710-1515
2 x 1 1/2	10 1/4	8	2 1/2	4 3/4	3	2015
2 x 2	11	9 1/4	3	5 1/2	4	2020

No. 6710 swivel drum trap "P" assembly consists of a No. 6715 inlet with a No. 6716 outlet and a No. 6650 KIMAX Coupling at the swivel joint.

6718

TRAP-P STYLE

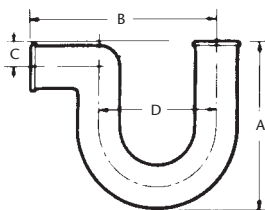

Size Inlet x Outlet	A	B	C	D	Art. No.
1 1/2 x 1 1/2	7	8	1	5	6718-1515 *
1) 2 x 1 1/2	8	8	1 1/2	5	2015 *
1) 2 x 2	8 3/16	8 3/4	1 1/2	5 1/2	2020 *
3 x 3	10 1/4	10 1/2	2	6 1/2	3030 *
4 x 4	12 1/4	12 1/2	2 1/2	7 1/2	4040 *
6 x 6	18 1/8	31	3 3/8	24	2) 6060 *

1) Use No. 6655 adapter coupling for inlet joint.

2) No cleanouts on 6 x 6 traps – consists of two glass components and one 6650-6000 KIMAX Coupling.

Use No. 6655 adapter coupling for inlet joint. Traps available with B type cleanout. See Standard Cleanout, Page 20.

Type B

STANDARD CLEANOUT

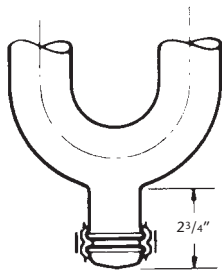

Size	Art.No.
1 1/2	B

Standard drainline trap cleanout Type B consists of a No. 6650 standard KIMAX Coupling (1 1/2") and a No. 6544 short glass cap (1 1/2").

Ordering Information:

To order standard traps with cleanouts use catalog number for proper style and add the letter B. (Example: 8718-B-1515). For correct layout dimensions add 2 3/4" to overall trap height for cleanout Type B.

Note: Traps manufactured with cleanouts are not returnable.

Accessories and Hardware

Size	Art.No.
1 1/2	6680-1500
2	2000
3	3000
4	4000

Adapter No. 6680 will fit standard straight or tapered threads. Used for same size pipe (e.g. 1 1/2" metal to 1 1/2" glass). Ideal for floor drain connections. In 1 1/2", 2", 3", and 4" sizes.

Size	Art.No.
2 x 1 1/2	6685-2015

Adapter No. 6685 is designed to mate 1 1/2" threaded tailpieces to 2" expanded inlets for KIMAX Traps. Can be moved up and down on tailpiece for space adjustments. In 2 x 1 1/2" size only.

Size	A	B	C	D	Art. No.
1 1/2	3 3/8	1/4	2 3/4	2	6720-1500
2	3 15/16	1/4	3	2 5/8	2000 *
2	3 3/8	1/4	3	2 5/8	6720D-2000

Consists of:
 6724 sink strainer (black fluorocarbon plastic) 1 1/2" or 2"
 6721 and 6721D sink outlet (black fluorocarbon plastic)
 6725 gasket-neoprene
 6722 locknut

Note: Hand tighten 6722 locknut to sink. DO NOT USE PIPE WRENCH. To fill gap in sink counterbore, use 3M-EC-612 caulking compound or equivalent. 1 1/2" and 2" size sink outlets are designed to accept standard overflows.
 For sink outlet tailpiece connections, see No. 6728 dimensions on Page 22.

Thread adapters are used to provide beaded end on threaded pipe for connecting directly to KIMAX Glass Drainlines with No. 6650 coupling. All TFE construction.

THREAD ADAPTERS (THREADED TO BEADED PIPE)

6680

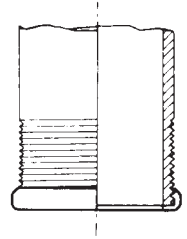

ADJUSTABLE THREAD ADAPTER

6685

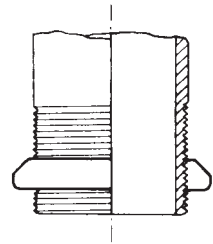

SINK OUTLET ASSEMBLY (1 1/2" AND 2" SIZES)
 2" FOR USE WITH SINKS HAVING 3 15/32" COUNTERBORE

6720

6720D

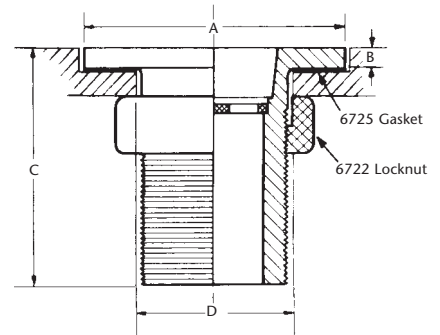

Use catalog dimensions for piping layout as gasket thickness allowance is included.
 *Manufactured per order. Not returnable.

6728 1 1/2" TAILPIECE ASSEMBLY

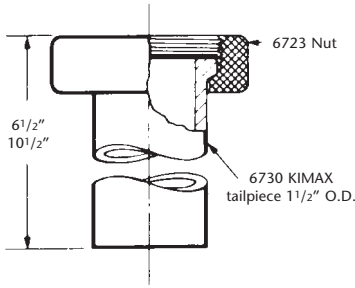

Size	Art.No.
1 1/2 x 6 1/2	6728-1060
1 1/2 x 10 1/2	1100

Components of 6728, 6723-Nut

Size	Art.No.
1 1/2	6723-1500

6730 Tailpiece

Size	Art.No.
1 1/2 x 6 1/2	6730-1060 *
1 1/2 x 10 1/2	1100

KIMAX Tailpiece is available in 6 1/2" and 10 1/2" lengths. Specify length when ordering. Glass is annealed and can be field cut to exact length. Assembly No. 6728 consists of a No. 6723 phenolic nut and a No. 6730 KIMAX Tailpiece.

Note: This assembly can be used on other 1 1/2" plastic or metal sink outlets having straight pipe threads. For metal outlet connections use gasket No. 6738 between metal and glass. Hand tighten coupling nut ...

DO NOT USE PIPE WRENCH.

6738 GASKET

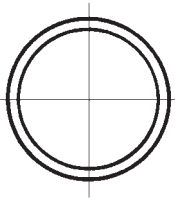

Size	Art.No.
1 1/2	6738-1500

Use gasket No. 6738 when connecting glass tailpiece No. 6728 to threaded metal pipe or plastic pipe.

6735 1 1/2" SPLIT COUPLING (THREADED TO BEADED PIPE)

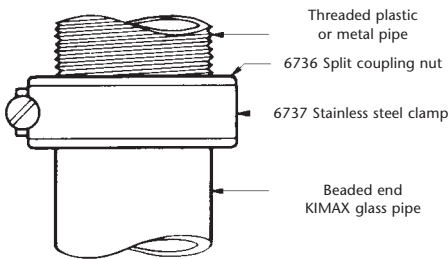

Size	Art.No.
1 1/2	6735-1500

No. 6735, 1 1/2" Split Coupling is used to join 1 1/2" beaded glass pipe to a threaded 1 1/2" I.P.S. pipe.

*The assembly consists of:
No. 6736 split coupling nut
No. 6737 stainless steel clamp*

To install ... remove clamp from split nut. Place split nut over beaded glass end. Replace clamp and tighten with screw driver.

6739 GASKET

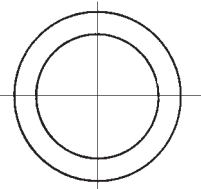

Size	Art.No.
1 1/2	6739-1500

Use gasket No. 6739 when connecting KIMAX Glass Pipe to threaded metal pipe, using No. 6735 split coupling.

7290 (1 1/2", 2", 3", 4", 6" SIZES) PIPE HANGERS (PADDED)

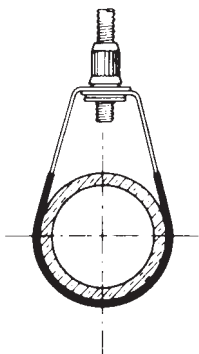

Size	Thread Diameter	Art. No.
1 1/2"	3/8 - 16	7290-1500
2"	3/8 - 16	2000
3"	3/8 - 16	3000
4"	3/8 - 16	4000
6"	1/2 - 13	6000

Recommended for horizontal runs. Hangers contain integral cushions. Standard finish on band is A.S.T.M. type L.S. zinc coating.

*Use catalog dimensions for piping layout as gasket thickness allowance is included.
Manufactured per order. Not returnable.

Portable Field Cutting Tools

KIMAX PORTABLE GLASS PIPE CUTTER

7310-56802

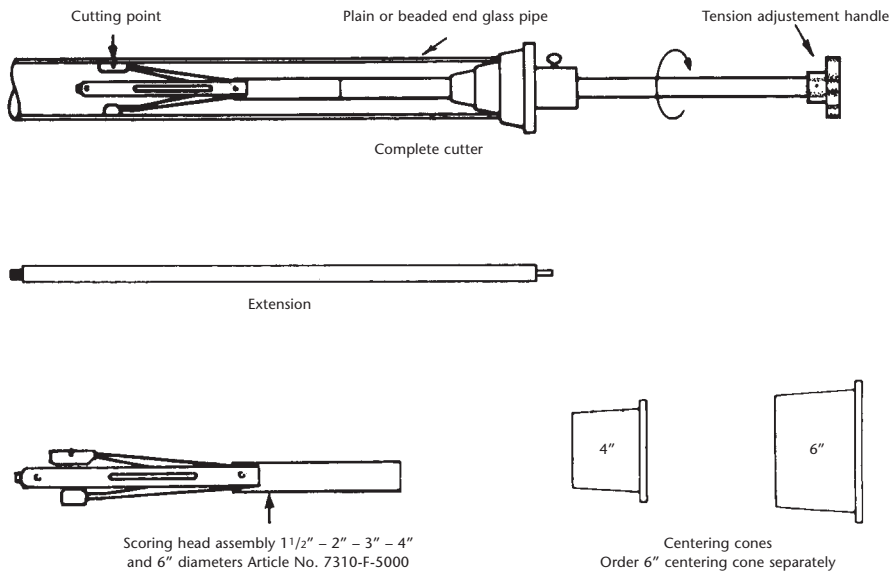

With the KIMAX Portable Glass Pipe Cutter you can cut 1 1/2" – 6" glass drainline pipe anywhere on the job site. Complete cutter consists of a scoring head assembly, extension, tension arm sub-assembly and 1 1/2" – 4" centering cones and ring stop as shown.

Order 6" centering cone separately.

KIMAX PORTABLE GLASS PIPE CUTTER
1 1/2 AND 2"

7310-2000

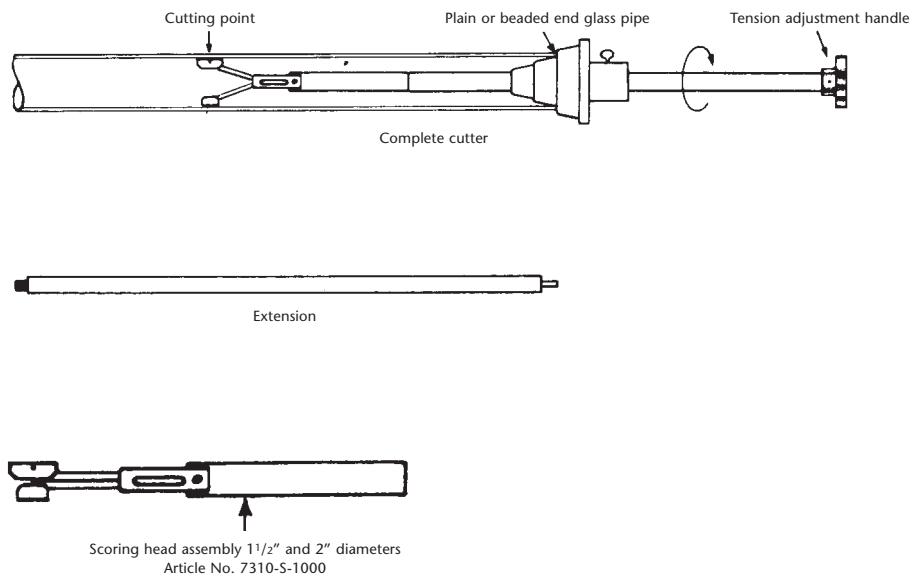

This KIMAX Portable Glass Pipe Cutter is designed specifically for faster field cutting of 1 1/2" and 2" pipe. Complete cutter consists of the new scoring head assembly, article number 7310-S-1000, plus tension handle and extension handle sub-assemblies and 1 1/2" – 2" cone.

See KIMAX Drainline Installation Guide for further information about cutting tools and for detailed installation and pipe cutting instructions. Installation guide and further information is available by contacting your local KIMAX Drainline distributor or SCHOTT North America, Inc.

Note: The cutter head, 7310-S-1000, illustrated to the left, connects to our standard extension handle and tension handles, enabling contractors to purchase the new head for use with existing handles.

Use catalog dimensions for piping layout as gasket thickness allowance is included.

Typical Joint Reference Chart

Type of Pipe

Type of Joint

Material needed

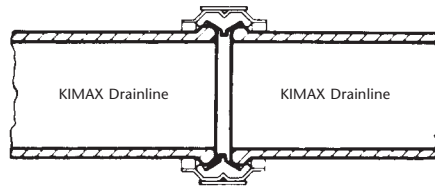
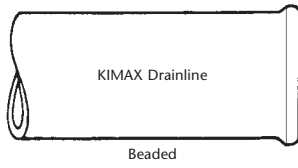

KIMAX Drainline Coupling 6650

Size	Art. No.
1 1/2	6650-1500
2	2000
3	3000
4	4000
6	6000

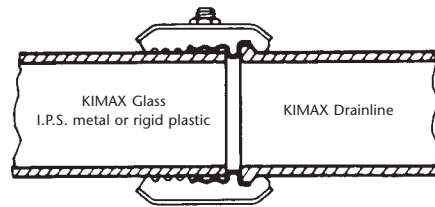
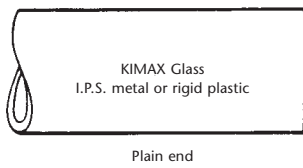

KIMAX B/P Coupling 6661

Pipe Size	Art. No.
1 1/2	6661-1500
2	2000
3	3000
4	4000
6	6000

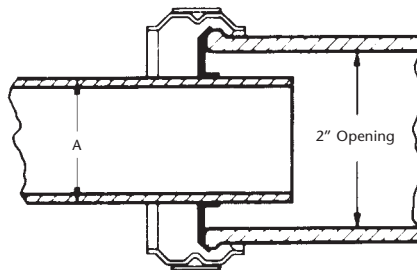
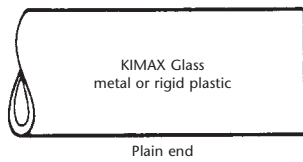

KIMAX Adapter Coupling

"A" Dimension	Coupling Size	Art. No.
1.48-1.53	2 x 1 1/2	6655-2015
1.70-1.78	2 x 1 3/4	2017
1.82-1.90	2 x 1 7/8	2018

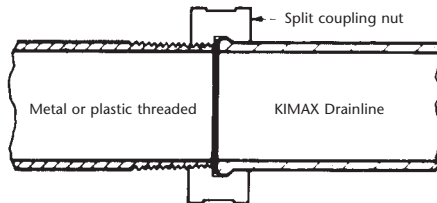
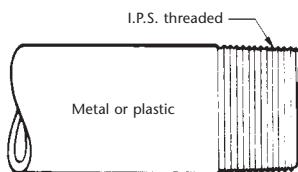

KIMAX Split Coupling

Pipe Size	Coupling Art. No.	Gasket Art. No.
1 1/2	6735-1500	6739-1500

Type of Pipe

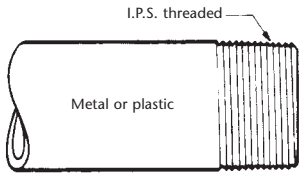

Type of Joint

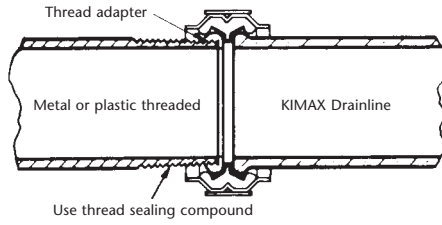

Material needed

KIMAX Thread Adapter and Drainline Coupling

Pipe Size	Adapter Art. No.	Coupling Art. No.
1 1/2	6680-1500	6650-1500
2	2000	2000
3	3000	3000
4	4000	4000

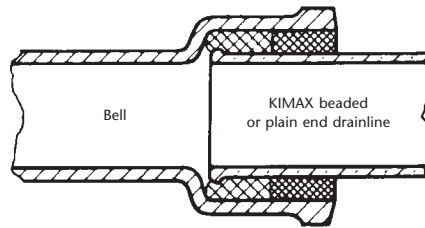
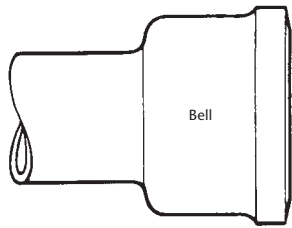

KIMAX Glass-to-Bell End Pipe

1. Pack hub half full with non-asbestos rope.
2. Caulk with hot lead, lead wool or acid-proof cement. For details, see *Drainline Installation Manual*.

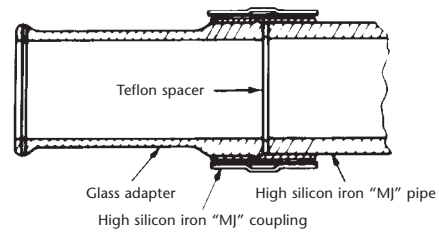

Glass Adapter to High Silicon Iron "MJ" Pipe

Pipe Size	Adapter Art. No.	MJ Coupling
1 1/2	6566-1500	Furnished
2	2000	by others
3	3000	
4	4000	

**Other SCHOTT Engineered Plumbing
System Products:**



KOCH KNIGHT-WARE®
Ceramic Neutralizing Sump Systems

Distributed by:

The information contained in this brochure is believed to be accurate and is offered in good faith by SCHOTT North America, Inc. However, suitability of our products for a given field application is the responsibility of the buyer and SCHOTT North America, Inc. accepts no liability for the appropriateness or adequacy of its products or information for any specific installation. Orders are subject to our standard terms and conditions of sale. SCHOTT North America, Inc. reserves the right to modify or delete at any time, products as illustrated and described in this publication.

*© Copyright of SCHOTT North America, Inc. 2006
All rights reserved*

*KIMAX is a registered trademark of Kimble Glass Inc.
KNIGHT-WARE® is a registered trademark for chemical stoneware manufactured by Koch Engineering Company, Inc. Knight Division/Ballard International.*

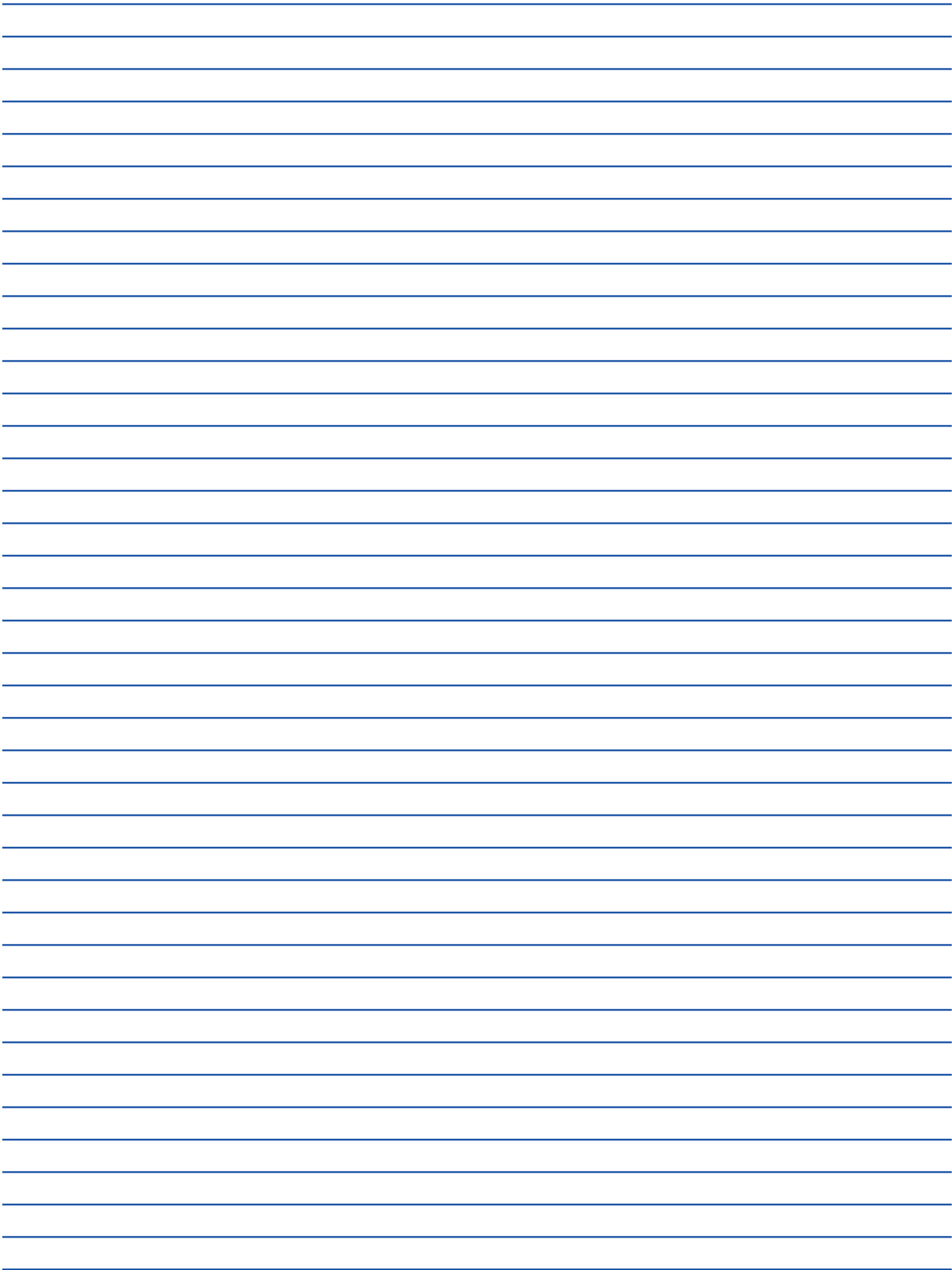

Tubing
SCHOTT North America, Inc.
555 Taxter Road
Elmsford, NY 10523
USA
Phone: (914)831-2200
Fax: (914)831-2368
E-mail: info.drainline@us.schott.com
www.us.schott.com/drainline

October 2006 Printed in the USA

SCHOTT
glass made of ideas